

Manual
liniLED® Dim 4-CASAMBI

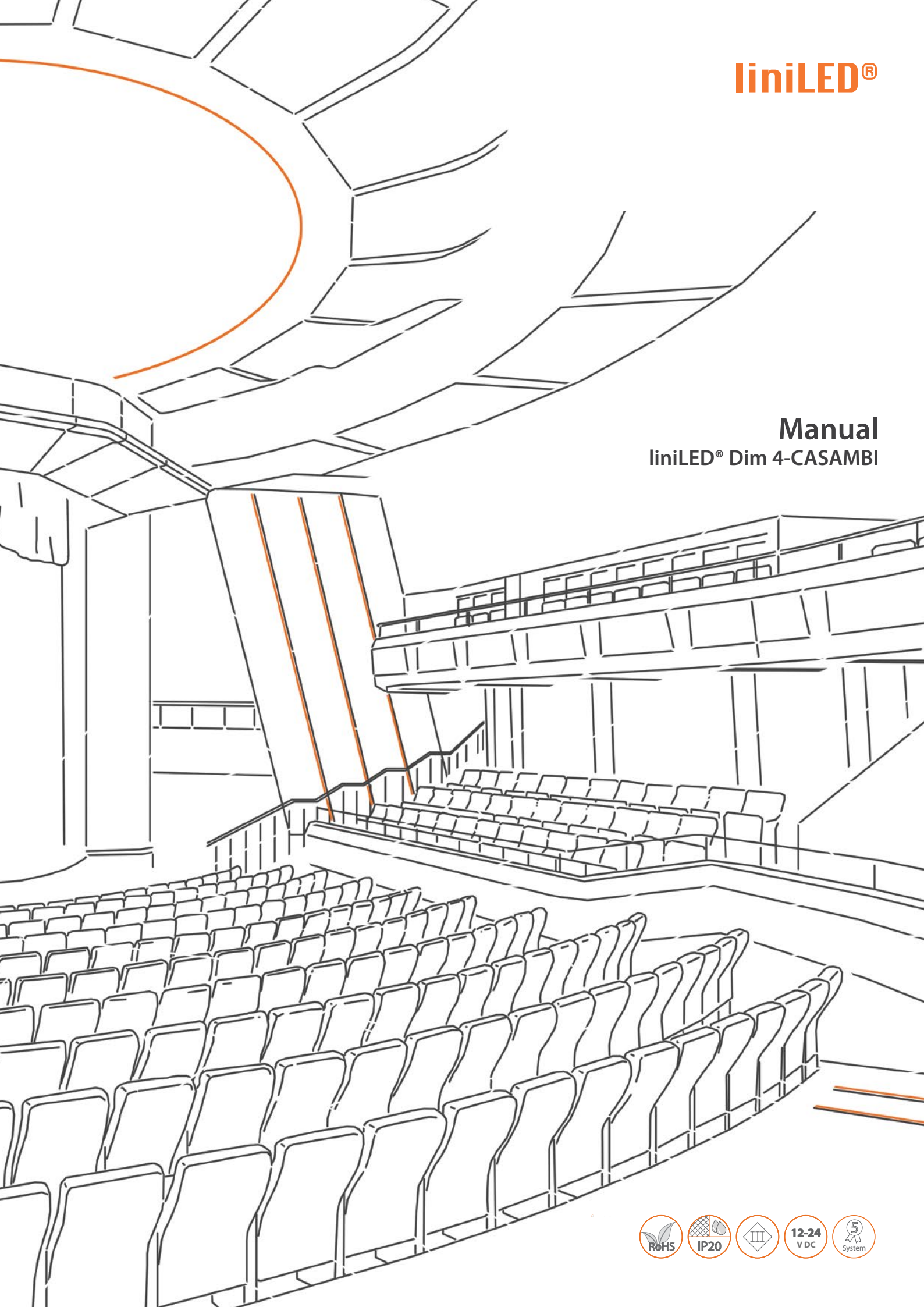

liniLED®

Dim 4-CASAMBI

Technical notes	4
Product drawing	5
Technical specifications	5
Type of profiles	6
Protection circuits	6
Reference standards	6
Wiring schemes	7
Installation	8
CASAMBI app	10
Symbols	12

Technical notes

Read the instructions and safety precautions before installation, usage and storage of the products to secure safety of the user and reliability of the product.

- Hand over the instructions to the end-user and those responsible for installation and usage.
- Triolight B.V. cannot be held responsible for improper handling, product installation, usage or storage.

Handling

- The product may not be modified or converted otherwise than described in this manual.
- Products are to be transported in proper packaging. Products should remain packed until installation.
- Take ESD (Electro Static Discharge) protection measures when handling liniLED® products.
- The products and their components may not be exposed to mechanical, static loads and other tension/compression other than from the product itself.

Installation

- Attention: the main power has to be switched off before installation. Not doing so may damage the product or cause injury.
- Installation has to be done by a professional with knowledge of electrical circuits or a certificated maintenance person known with valid directives.
- General and local construction-, safety- and installation regulations must be followed.
- Use only supplied parts, accessories and required tools as prescribed in the installation manual to guarantee a safe installation and use of the product.
- Products may solely be installed in the areas according to their prescribed IP-rating, IK-rating, temperature range and chemical resistances.
- The product must be installed inside an electrical housing protected against overvoltages.
- The product must be installed in a vertical or horizontal position with the cover/ label upwards or vertically; other positions are not permitted.
- It is not permitted to bottom-up position (with the cover/label down).
- Do not install the product in the following cases:
 - Damage is visible on the product or its cables
 - The inside of the product is moistened or dirty
 - The product or its cables have been modified. It could lead to an electrical shock or a short circuit may occur.

Cables

- All cables used in the setup must be dimensioned properly and should be isolated from any other wiring or electronic conductive parts. It is suggested to use double insulated and if applicable shielded and twisted cables.
- The length of the connecting cables between the product and the LED module must be less than 10m.
- The length of the connecting cables between the control inputs (pushbutton, 0-10 V/1-10 V, potentiometer or other) and the product must be less than 10m.

Operation and use

Solely use the product when its working correctly. If not, switch the power off immediately and advise an electrical specialist in the following cases:

- Damage is visible on the product.
- The product does not function.
- Smoke or steam rises from the product.
- Crackling sounds are noticeable.

- Repairs on the installation may only be performed by qualified electricians.
- Product repairs may solely be done by Triolight B.V.
- Use a suitable power supply.
- Do not drive the product on other voltages than described in their datasheet/product specifications.
- Do not fasten anything on the product, same applies for hanging.
- Children may not play unsupervised with electrical products as they cannot judge the dangers in dealing with electrical circuits correctly.

Cleaning and maintenance

- *Attention:* Disconnect the power before maintenance and cleaning.
- Paints, solvents and corrosive cleaning chemicals may not contact and thus affect the product.

Environment and waste

- This product may not be treated as household waste. Dispose of the material through the waste recycling of electrical and electronic equipment.

Documentation

- For an updated version of the device manual visit our website: www.liniled.com.

Product drawing

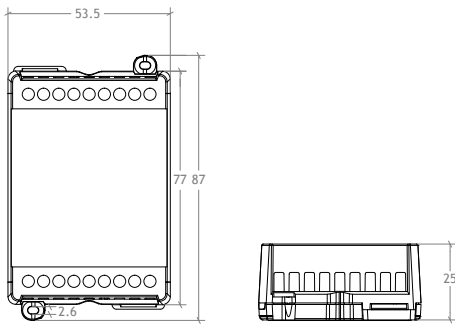

Technical specifications

Dim 4-CASAMBI

Product code	11133
Input signal	CASAMBI App (iOS or Android) using BLE/Bluetooth 4.0 4 dry contacts for N.O. pushbuttons
Input voltage (V_{in})	10.8 ... 26.4 V DC
Input current (I_{in}) ¹	Max. 10 A
Max. load @ 24 V DC ¹	240 W
Output channels	4
Output current per channel ^{1,2}	Max. 5 A
Output signal ³	D-PWM, 833 step resolution
Output type	Constant voltage, common anode
Output voltage (V_{out})	$= V_{in}$
Typical efficiency	> 95%
Standby power @ 24 V DC	Max. 500 mW
Dimming range	0 ... 100%
Dimming frequency ³	600 Hz
IP rating	IP20
Storage temperature	-40 ... 60°C
Ambient operating temperature (T_a) ¹	-10 ... 40°C
Dimensions	87 x 54 x 26 mm
Packaging dimensions	106 x 59 x 36 mm
Weight	80 g
Housing material	Self-extinguishing PC/ABS
Thermal shutdown ⁴	150°C
Wiring	2.5 mm ² solid - 1.5mm ² stranded - 30/12 AWG
Output signal power rating ³	4 dBm
Max. signal range	40 metres indoor/50 metres open field

¹ Maximum value, dependent on the ventilation and environmental conditions.

² Max load definition: 10 A ($I_{TOT} = I_{L1} + I_{L2} + I_{L3} + I_{L4}$). Each channel provides max 5 A.

³ The values depend on the configuration of the CASAMBI module.

⁴ Provided by MOSFET internal thermal shut down.

Protection circuits

OTP	Over temperature protection ⁴
OVP	Over voltage protection ⁵
UVP	Under voltage protection ⁵
RVP	Reverse polarity protection ⁵
IFP	Input fuse protection ⁵
SCP	Short circuit protection
CLP	Current limit protection

⁴ Provided by MOSFET internal shut down.

⁵ Only control logic protection.





Reference standards

This product is designed and produced according to following standards.

EN 61347-1:2008 + A1:2011 + A2:2013	Lamp control gear - Part 1: General and safety requirements
EN 55015:2013+A1:2015	Limits and methods of measurement of radio disturbance characteristics of electrical lighting
EN 61547:2009	Equipment for general lighting purposes - EMC immunity requirements
EN 50581:2012	Technical documentation for the assessment of electrical and electronic products with respect to the restriction of hazardous substances

Type of profiles

The driver supports four types of colour scheme profiles with a corresponding number of output channels. The options are described in the table below.

	Profile	Supply voltage	Output	Channels	Commands
	Dim 4-CASAMBI MONO	12-24 V DC	4x CV	4	APP CASAMBI - 4 N.O. pushbuttons
	Dim 4-CASAMBI TW	12-24 V DC	2x CV	2	APP CASAMBI - 4 N.O. pushbuttons
	Dim 4-CASAMBI RGB	12-24 V DC	3x CV	3	APP CASAMBI - 4 N.O. pushbuttons
	Dim 4-CASAMBI RGBW	12-24 V DC	4x CV	4	APP CASAMBI - 4 N.O. pushbuttons

Wiring schemes



Installation

This chapter is described in the correct installation order, we advise you to follow this order.
For optimal functionality of the CASAMBI signal, do not put the device into metal or aluminum boxes and do not shield the device.

Tools required for installation:

- 1 x Phillips screwdriver
- 2 x Screw (e.g. $\varnothing 2.9 \times 6.5$ mm screw)
- 1 x Flat screwdriver 2-3.5 mm
- 1 x Power meter (optional for checking driver input voltage)

⚠ Danger! Turn off the power before starting the installation!

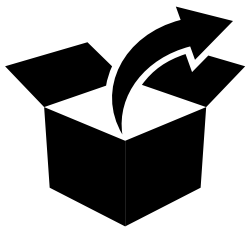

1. Unpack the driver and check for any damages. **Note:** Never install a damaged driver and report any defects immediately to your supplier.

2. Make sure that a proper SELV driver suitable to drive LED strips is installed and ensure that the output voltage is within limits of the LED strip specifications. For LED strip operating voltages, please check respective product datasheet.

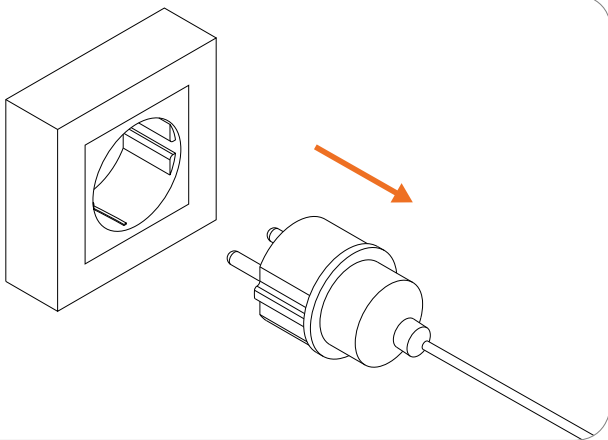

3. Disconnect the power supply from the mains voltage.

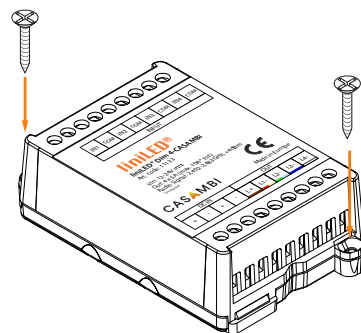

4. Install the driver on a suitable surface by screwing it in place using the screwholes.

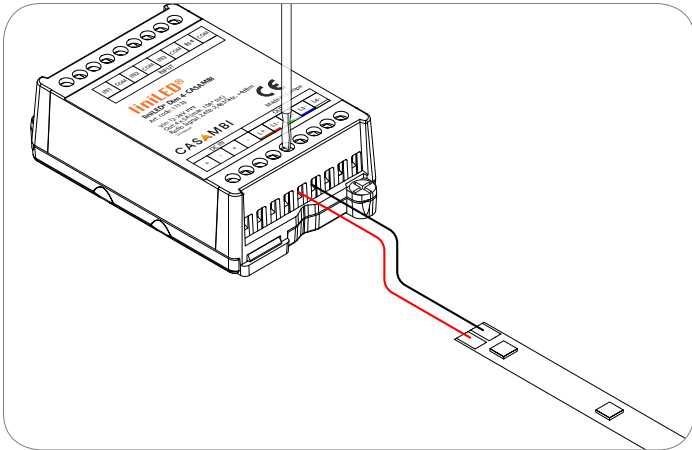

5. Connect the LED strip wires to the outputs according to the wiring scheme on page 7.

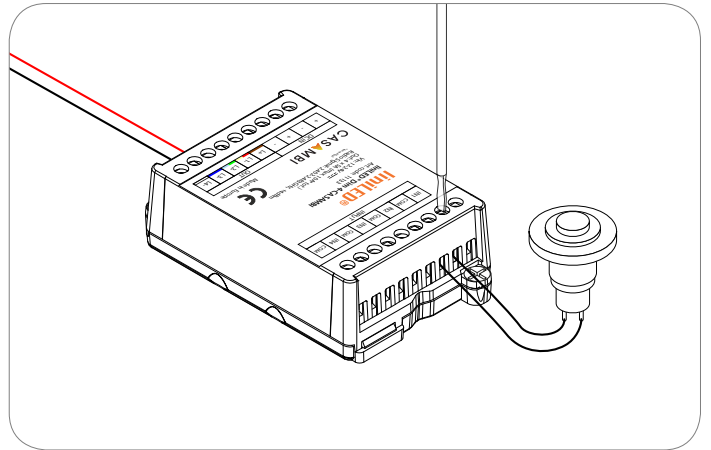

6. Optional: Connect the pushbutton(s).

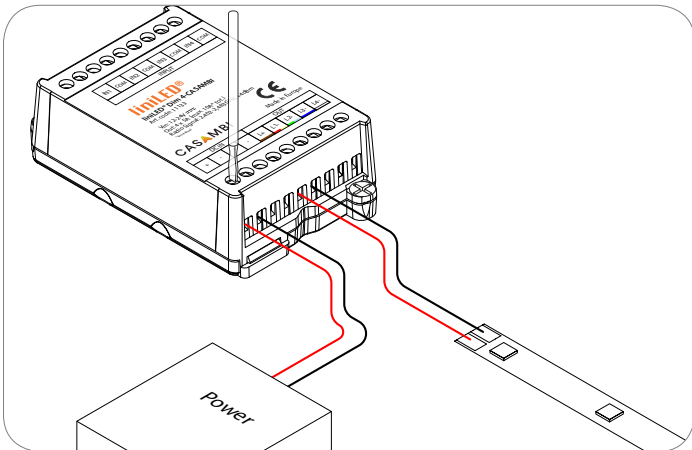

7. Connect the power supply.

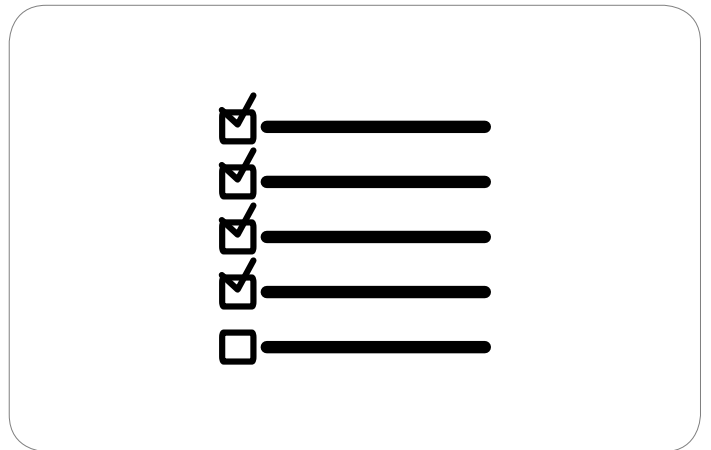

8. Double check the wiring and connections.

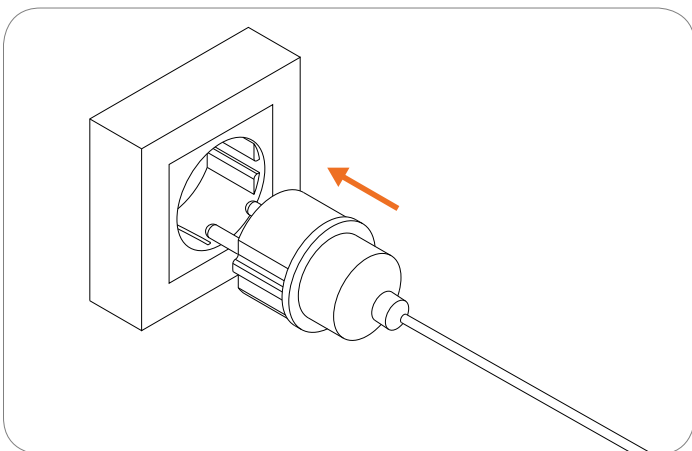

9. Connect the power supply to the mains voltage and power up the driver. The driver can now be configured through the CASAMBI app for further use.

CASAMBI app

Download the free CASAMBI app from the Apple App store or Google Play Store.



Update your firmware before use to ensure compatibility and optimal functionality.

The default setting of the controller is RGB if you want to change this please follow the next steps.

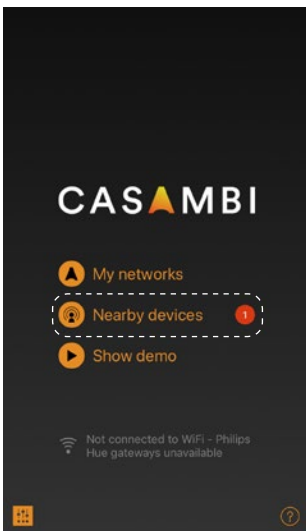

1. Press *Nearby devices*

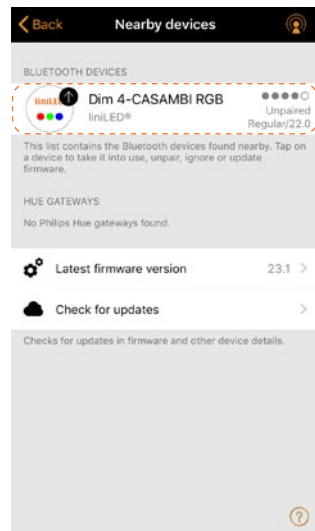

2. Select bluetooth device

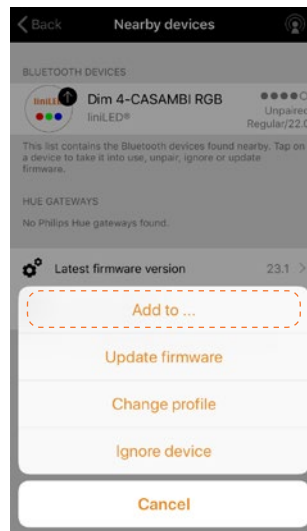

3. Select *Add to ...*

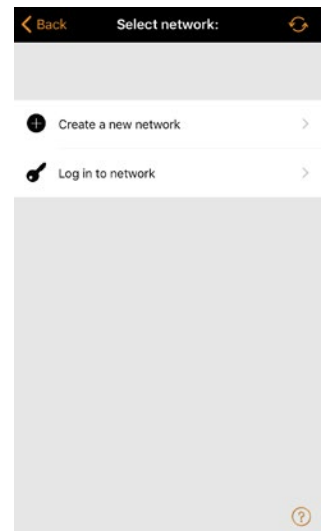

4. Create new network or choose existing network

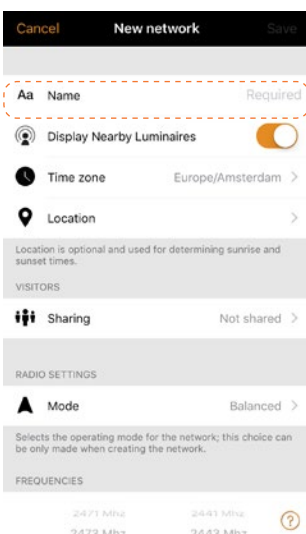

5. Enter a new network name (Only for new network)

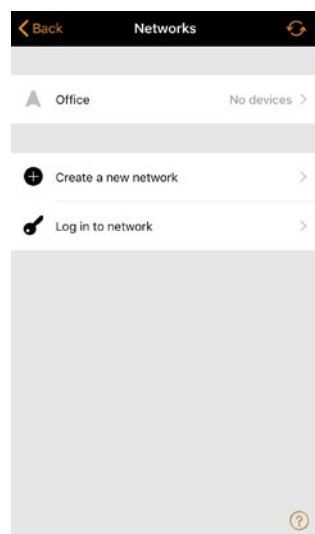

6. Select network

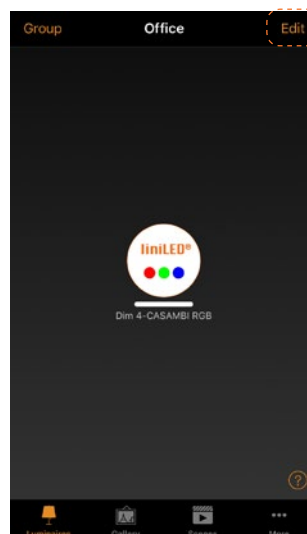

7. Make sure you are in the luminaires tab and press *Edit*



8. Select device (attention: do not press 'X')



9. Scroll down and select *Unpair device*

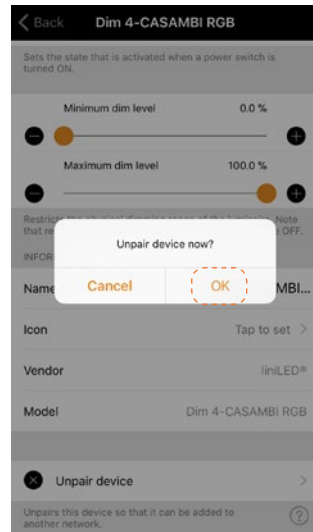

10. Press *OK*

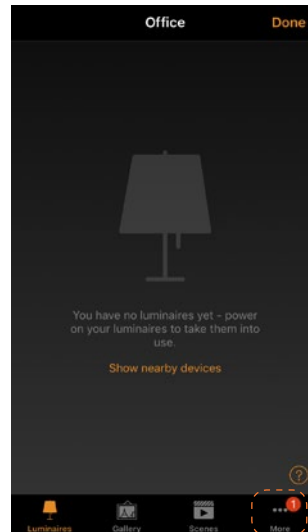

11. Select *More*

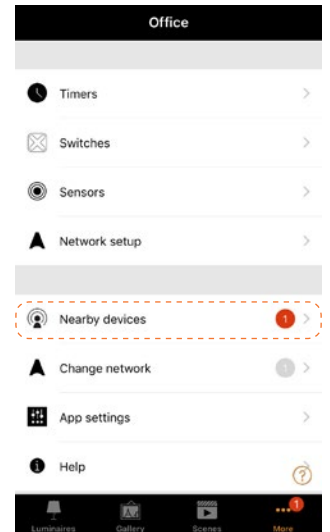

12. Select *Nearby devices*

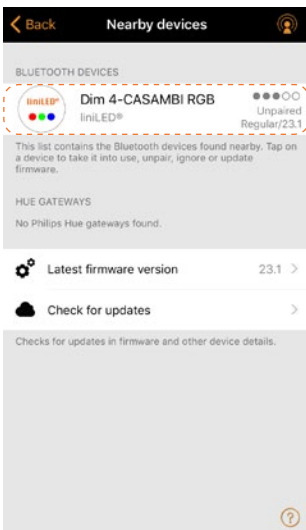

13. Select device

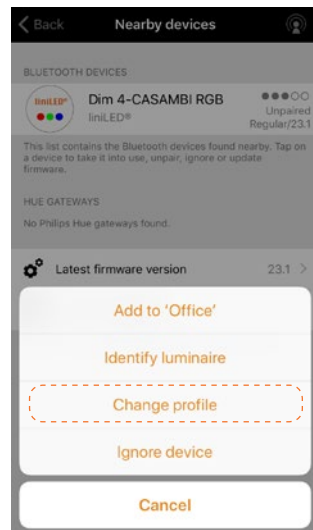

14. Select *Change profile*

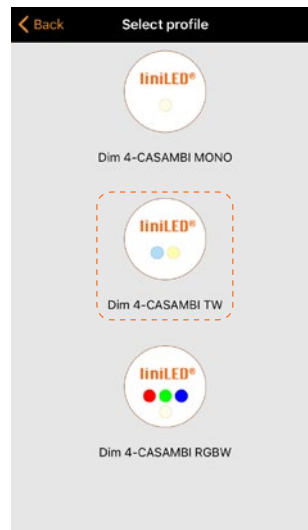

15. Select the profile you want (TW in this example)

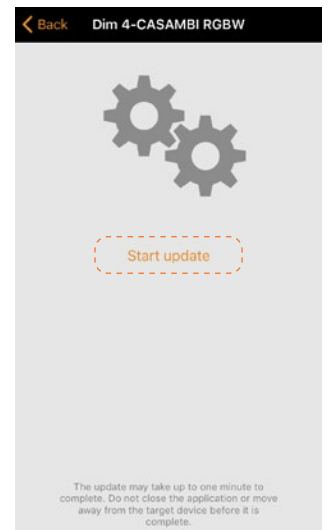

16. Select *Start update*

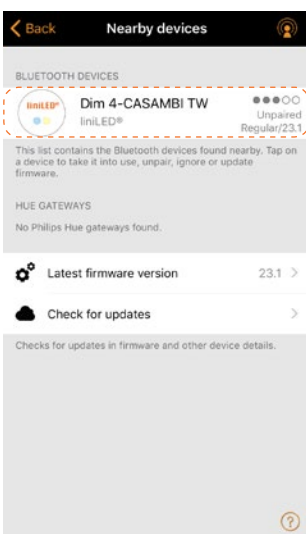

17. Select device

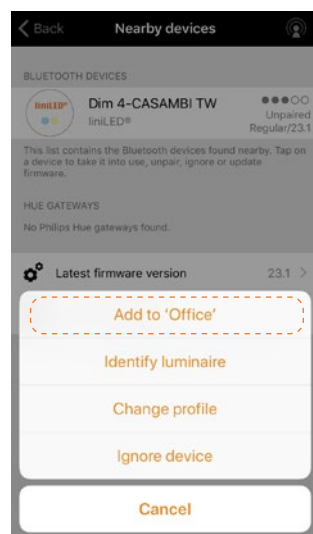

18. Select *Add to 'network name'*

The device is now ready to use.

Symbols



Manufacturer's declaration that the product meets the applicable EC directives.



Restriction of Hazardous Substances (RoHS): product complies with the RoHS directive and each homogeneous material does not exceed the limits for the materials mentioned under the RoHS directive (Pb, Hg, Cd, Cr6+, PBB and PBDE).



Protected against ingress of solid foreign objects ≥ 12.5 millimetres. Not-protected against ingress of water.



Electrical appliance class III: this product is designed to be supplied from an extra-low voltage (≤ 60.0 V DC or ≤ 42.4 V AC).



Operating voltage of 12-24 V DC (please check or refer to LED product specification).



System guarantee of 5 years when the complete system consist of liniLED® products with the 5 years system warranty logo. Terms & conditions apply.

Disclaimer

The published information is checked to be as accurate as possible, however Triolight B.V. or any reseller of liniLED® cannot be held liable for any damages resulting from errors or outdated information. Triolight B.V. reserves the right to modify the information without informing the customers. When this document is printed or downloaded, please check for the latest version on the internet, the most up to date information will be published on www.liniLED.com. This product should not be used in applications, devices or systems where incorrect operation of the product may result in personal injury (includes emergency lighting) without written permission from the board of Triolight B.V. If nevertheless used in such applications, devices or systems Triolight B.V. cannot be held liable for any resulting injury.

